

# Ceník 2018

uvedené ceny jsou v CZK bez DPH  
platné od 1.1.2018 do 31.12.2018

HÅG

Celebrating movement



## Content

---

General Terms	4
HÅG SoFi®	6
HÅG Capisco®	8
HÅG Capisco Puls®	9
HÅG Futu®	10
HÅG Executive	12
HÅG H05®	17
HÅG H04®	20
HÅG H03®	22
HÅG Conventio®	23
HÅG Conventio Wing®	25
HÅG Accessories	27
Main spare parts	28
Physical measurements	34
Tests and Certificates	38
HÅG Fast	40
HÅG Total Colour Extended Collection	41
HÅG Colour and Fabrics	43
HÅG Total Colour Standard Collection	45

# General Terms

## Standard dispatch times

### Dispatch times

HÅG Fast (after order has been registered)  
HÅG Total Colour Standard  
HÅG Total Colour Extended  
Special and COM  
Transport-days must be added.

### Working days

10 - 15  
15 - 20  
25 - 30\*  
on request

\* Provided that the supplier has the fabric in stock.  
Longer delivery times may occur periodically, during holidays and for large orders.

## Order Entry Specifications

When placing your order please remember to specify the following information:

- Chair model
- Number of chairs
- Fabric/Leather and Colour Code
- Plastic colour on HÅG Conventio Wing
- Plastic colour on HÅG Capisco Puls
- Colour on base
- Type of castors or glides
- Delivery date
- Delivery address

### Colour on base.

Where a base is specified in black, other metal components will be in black also. Similarly, chairs on silver bases have metal components in silver.

Other metal colours need to be specified for chairs with polished aluminium bases (extra cost option). Specified combinations are defined for:

HÅG SoFi  
HÅG Executive  
HÅG H05 Communication

### Castors

Both hard and soft castors and glides are supplied according to EN1335 Class A standard, and must be specified at time of order (soft for hard flooring, hard for soft flooring). Additional castor options are available on request, but must be specified at time of order and the delivery lead time may be increased. Price on application.

## Packaging material - recycling

We encourage you to ensure recycling of all packaging material. Please sort and return the packaging material, using your local recycling partners/stations - and follow your local regulations.  
If you have questions on how to handle waste packaging material, please inform your contact person within Flokk.

## Prices

All prices are recommended retail prices in Euro excl. VAT.  
Any typographical errors shall not be binding for Flokk and will be subject to correction without liability to the vendor.

## Delivery Terms

EX WORKS ref. Incoterms 2010.

In the case that goods have been damaged in transit, the recipient/customer must inform the supplier within 48 hours of receipt.

## HÅG Warranty

### General terms and conditions.

Flokk's warranty covers all HÅG chairs against material and manufacturing faults and defects from the chair's production date. The warranty covers any necessary spare parts. Labour and transport costs are not covered. Wear and tear must be expected from normal use and are not covered by the warranty. Unless otherwise is specified, the maximum weight for users is 110 kg. The warranty is conditional on the chair and fabrics/leather undergoing normal cleaning. The guarantee does not cover the consequence of wear and stains when choosing a light (white) colour for plastic or metal components.

### 10 year warranty for HÅG products and accessories

Flokk provides a 10 year warranty for all HÅG chairs and accessories that are in normal use for up to 9 hours per day. Please also see the general warranty terms and conditions.

### 24/7 – 5 year warranty.

Flokk provides a 5 year warranty for HÅG chairs that are specifically purchased for 24 hour use and which are upholstered in 24/7 approved fabrics/leather from Flokk's Standard Fabric program. Please also see the general warranty terms and conditions.

### >9 hours/day – 5 year warranty.

Flokk provides a 5 year warranty for all HÅG chairs that are in normal use for more than 9 hours per day. Please also see the general warranty terms and conditions.

### Spare parts guarantee.

Flokk guarantees the delivery of spare parts for a minimum of 10 years after the chair's production date. The guarantee covers the parts necessary to maintain the chair's original functionality.

## HÅG Total Colour (HTC) collection

### HÅG Total Colour (HTC) Standard fabric/colour program.

Flokk provides a 10 year warranty for fabrics/leather from the HTC Standard collection when the chair is in normal use for up to 9 hours per day. Flokk provides a 5 year warranty for fabrics/ leather from the HTC Standard collection when the chair is in normal use for more than 9 hours per day.

### HÅG Total Colour (HTC) Extended fabric/colour program.

Flokk provides a 5 year warranty for fabrics/leather from the HTC Extended collection when the chair is in normal use for up to 9 hours per day. Some of the fabrics in the HTC Extended collection are available with a 5 year warranty for 24 hour use (for use of more than 9 hours per day).

### Special or Customer specified fabrics/leather.

If the fabrics in the HÅG Total Colour (HTC) Standard or Extended collections are not what you are looking for, please contact Customer Service at Flokk, email: info-gpo@flokk.com. The general warranty terms and conditions cover the chair against material and manufacturing faults, but not the upholstery. This does not affect your rights and obligations under local law. Customer specified fabrics/leather can only be used following approval by Flokk.

## Approvals and Certifications

Flokk is ISO 9001 accredited. The German test institutes, LGA and Intertek, have approved and issued the GS certificate (Geprüfte Sicherheit) for a number of HÅG products.

- HÅG task chairs are tested in accordance with both EN 1335 Type A (European office chair standard) and ANSI Bifma (American standard).
- HÅG conference and visitor chairs are tested in accordance with EN 13761, EN 16139 and the ANSI Bifma standard.
- HÅG SoFi, HÅG Futu, HÅG H04, HÅG H05 and HÅG Executive are tested according to British Standard BS 5459-2, a commonly used standard for intensive use (24 hours).

EN 1335 is a European Standard for office chairs and considers dimensions of the chair, safety requirements and safety test methods. The European Standard tests are based on 8 hours daily use by persons weighing up to 110 kg (17¼ stone).

The British Standard (BS 5459-2) tests that the chair will be suitable for more than 8 hours daily use and for persons weighing up to 150 kg (23½ stone).

The majority of HÅG products are tested and approved according to the Swedish Möbelfakta requirements.

## ESD (Electro Static Discharge).

We can supply HÅG H04 4100, HÅG H05 5400, HÅG Capisco Puls 8001, 8010 and HÅG Capisco 8106 as ESD chairs upholstered in anti-static synthetic leather (Nevotex) or Global ESD (Bogesunds). For HÅG Capisco Puls the price will be price group 5 + 25%. Flokk provides a 5 year warranty on ESD chairs, conditional on castors and upholstery being cleaned regularly with a suitable cleaning agent.

## Cleanroom

We can supply HÅG Capisco Puls 8010 for Cleanroom, upholstered in Antistatic synthetic leather (please see HÅG Total Colour Extended Collection for further info). Flokk provides a 5 year warranty on cleanroom finished chairs, conditional on castors and upholstery being cleaned regularly with a suitable cleaning agent.

## Maintenance guide

### Care of fabric upholstery:

Regular vacuum cleaning is recommended. Vacuum clean the chair with a furniture brush or wipe it with a clean white cloth or sponge slightly dampened with lukewarm, clean water. Marks and stains should be removed with a proprietary cleaner.

### Care of leather upholstery:

Wipe with a slightly damp cloth and gently rub dry. A good proprietary hide food should be applied at least once a year and more often if the leather is in a dry atmosphere or close to a heat-source.

Do not remove any plastic parts or attempt to open the seating mechanism.

Contact your Flokk dealer if the chair requires servicing or other maintenance. For additional maintenance advice please contact our customer service team.

## End of life – recycling

We encourage you to ensure recycling of your chair and its various components, according to the 'end of life matrix' described in your chair's user manual. Please dispose your chair/components using your local recycling partners/stations - and follow your local regulations. If you have questions on how to dispose or return your chair after use, please inform your contact person within Flokk.

## Fire resistant foam

Flame resistant foam is available on request, but must be specified at time of order and adds approximately two to five weeks to delivery lead times. Price on application. CHMR foam must be specified on chairs intended for domestic use.

## Change/cancellation of orders

Change/cancellation of orders on chairs or upholsteries is possible up until production has begun. Each amended or cancelled order will incur a charge of Euro 50 per order. Once production has started orders cannot be changed. Change of orders within the HÅG Fast collection are not possible.

For further information regarding change /cancellation of orders, please feel free to contact our Customer Service department.



## Customer Service

Flokk  
Phone: +47 7240 7240  
E-mail: info-gpo@flokk.com

Flokk reserves the right to make small construction alterations without notice.

# HÅG SoFi® – task chairs

- HÅG in Balance® (balanced, flowing tilt function backwards and forwards)
- Seat depth adjustment
- Seat height adjustment
- Adjustable lumbar support
- Adjustable tilting resistance forwards and backwards
- Lockable tilt
- Five star base (Ø730 mm) in aluminium with footplates. Standard aluminium in black with black plastic, silver or white with light grey plastic parts. Optionally in polished aluminium. Please specify colour at time of order
- Castors for hard or soft flooring. Must be specified at time of order
- 165 mm lift (Seat height: 396-543 mm)
- Painted aluminum colours: black, silver or white
- Plastic colours: black or light grey

Item no	Base model +	Price Group	①	②	③	④	⑤	⑥	Price
7500	HÅG SoFi 7500 • Mesh back. The mesh back comes in black (MEH001) or grey (MEH002) and matches the frame colour. • High back		19432	19852	20552	21364	22148	25480	
7200	HÅG SoFi 7200 • Medium back		23072	23716	24752	25984	27132	32116	
7300	HÅG SoFi 7300 • High back		24416	25060	26152	27468	28700	33908	
<b>Accessories/Options</b>									
	Headrest		6608	6776	6888	7112	7560	8512	
	Adjustable armrests in plastic with soft tops (width 92 mm) and stem in painted aluminium								4620
	- Surcharge for armrests in painted aluminium with soft tops (width 102 mm) and stem in aluminium								728
	- Surcharge for armrests in black plastic with soft tops (width 92 mm) and stem in polished aluminium								1596
	- Surcharge for armrests in polished aluminium with soft tops (width 102 mm) and stem in polished aluminium								3332
	- Surcharge for armrests with HÅG SlideBack								1148
	- Surcharge for armrests with leather tops, black or dark grey (For armrest in aluminium)								1876
	- Surcharge for armrests with 3D tops (for armrest in plastic)								1008
	200 mm lift								280
	HÅG FootRing**								2968
	Footbase (Ø730 mm) in polished aluminium								2968
	Decorative stitching*								2436

\* Available for all models, but only for seat on HÅG SoFi with mesh back. Please see HÅG Colour and Fabrics for additional information.

\*\* Must be ordered together with 200 mm lift.

# HÅG SoFi® – Communication chairs

- HÅG in Balance® (balanced, flowing tilt function backwards and forwards)
- Seat depth adjustment
- Seat height adjustment
- Lumbar support
- Four star aluminum base (785mm) available in black, silver or white as standard with polished aluminum as an optional extra. Mechanism cover is black when ordering black base and light grey when ordering silver or white base. Please specify when placing your order.
- Plastic glides for soft flooring or felt glides for hard flooring. Must be specified at time of order.
- 165 mm lift (Seat height: 400-550 mm)
- Painted aluminum colours: black, silver or white
- Plastic colours: black or light grey

Item no	Base model +	Price Group	①	②	③	④	⑤	⑥	Price
7502	HÅG SoFi Communication 7502 <ul style="list-style-type: none"> <li>• Mesh back. The mesh back comes in black or grey and matches the frame colour.</li> <li>• High Back</li> </ul>		13748	14028	14532	15092	15652	17976	
7202	HÅG SoFi Communication 7202 <ul style="list-style-type: none"> <li>• Medium back</li> </ul>		16632	16996	17584	18284	18956	21812	
7302	HÅG SoFi Communication 7302 <ul style="list-style-type: none"> <li>• High back</li> </ul>		18060	18452	19096	19852	20580	23688	





## Accessories/Options

Adjustable armrests in plastic with soft tops (width 92 mm) and stem in painted aluminium	4620
- Surcharge for armrests in painted aluminium with soft tops (width 102 mm) and stem in aluminium	728
- Surcharge for armrests in black plastic with soft tops (width 92 mm) and stem in polished aluminium	1596
- Surcharge for armrests in polished aluminium with soft tops (width 102 mm) and stem in polished aluminium	3332
- Surcharge for armrests with leather tops, black or dark grey (For armrest in aluminium)	1876
Four star base (Ø785 mm) in polished aluminium	2044
Five star base (Ø730 mm) in painted aluminium, black or silver, with castors (as for task chair)	na dotaz
Five star base (Ø730 mm) in polished aluminium with castors (as for task chair)	2912
Decorative stitching*	2436

\* Available for all models, but only for seat on HÅG SoFi with mesh back. Please see HÅG Colour and Fabrics for additional information.

# HÅG Capisco® - task chairs

- HÅG in Balance® (balanced, flowing tilt function)
- Adjustable tilt tension backwards (not available for 8105)
- Seat height adjustment
- Seat depth adjustment (not available for 8105)
- Back height adjustment (not available for 8105)
- Lockable seat (not available for 8105)
- Suitable for all working surfaces with table height of 72 cm and higher
- Five star base in aluminium (Ø730 mm) with curved/arched footplates, black, silver or white, optionally in polished aluminium (see options below). Please specify colour at time of order
- 200 mm lift (Seat height: 470-655 mm). 265 mm lift standard for 8105 (Seat height: 570-810 mm)





Item no	Base model +	Price Group	①	②	③	④	⑤	⑥	Price
8105	<u>HÅG Capisco 8105</u>		12068	12236	12768	13272	14252	15792	
8106	HÅG Capisco 8106 • Available as electro static discharged (ESD) chair (PG 6 + 10%)		29260	29652	30940	32116	33068	38416	
8107	HÅG Capisco 8107 • Headrest (only available in silver and black)		35028	35644	37240	38724	39648	46116	
8126	<u>HÅG Capisco 8126</u>								
8127	HÅG Capisco 8127 • Headrest (only available in silver and black)								
<b>Accessories/Options</b>									
	150 mm lift								0
	265 mm lift (glides are recommended, no additional charge)								252
	Telescopic lift cover								364
	Five star base (Ø730 mm) in polished aluminium								3164
	Decorative stitching*								2436
	HÅG StepUp								4200
	HÅG FootRing**								2968

\* Available for model 8105, 8106 and 8107. Please see HÅG Colour and Fabrics for additional information.

\*\* Must be ordered together with 200 or 265 mm lift

# HÅG Capisco Puls® - task chairs

- HÅG in Balance® (balanced, flowing tilt function)
- Adjustable tilt tension backwards (not available for 8001 and 8002)
- Seat height adjustment
- Seat depth adjustment (not available for 8001 and 8002)
- Back height adjustment (not available for 8001 and 8002)
- Lockable seat (not available for 8001 and 8002)
- Suitable for all working surfaces with table height of 72 cm and higher
- Seat and backrest available in 8 different colours: Clay, Pink, Sea Green, Petroleum, Light Grey, Black, White and Red. Please specify colour at time of order.
- Five star base (Ø730 mm) in aluminium with curved/arched footplates, black, silver or white, optionally in polished aluminium or black plastic base (Ø700 mm). Please specify colour at time of order.

Item no	Base model +	Price Group	①	②	③	④	⑤	Price
8001	HÅG Capisco Puls 8001 <ul style="list-style-type: none"> <li>• Pad available in all HTC Standard fabrics and leather***</li> <li>• Seat height: 540-770 mm</li> <li>• 265 mm lift</li> <li>• Available as electro static discharged (ESD) chair (PG 5 + 25 %)</li> </ul>		8540	8708	9156	9408	10164	
8002	HÅG Capisco Puls 8002 <ul style="list-style-type: none"> <li>• Removable seat cushion in Nexus, Sprint or Evida*</li> <li>• Seat height: 555-785 mm</li> <li>• 265 mm lift</li> </ul>					11396	11788	
8010	HÅG Capisco Puls 8010 <ul style="list-style-type: none"> <li>• Available for Cleanroom upholstered in Antistatic synthetic leather</li> <li>• Pad available in all HTC Standards and leather***</li> <li>• Seat height: 455-620 mm</li> <li>• 200 mm lift</li> <li>• Available as electro static discharged (ESD) chair (PG 5 + 25 %)</li> </ul>		11704	11900	12432	12880	13888	
8020	HÅG Capisco Puls 8020 <ul style="list-style-type: none"> <li>• Removable seat cushion in Nexus, Sprint or Evida*</li> <li>• Seat height: 470-635 mm</li> <li>• 200 mm lift</li> </ul>					13580	4056	

## Accessories/Options

150 mm lift	0
265 mm lift (glides are recommended, no additional charge)	252
Telescopic lift cover	364
Five star base (Ø730 mm) in polished aluminium	3164
Five star base (Ø700 mm) in black plastic	-392
HÅG FootRing**	2968
HÅG StepUp	4200

\* Removable seat cushion for HÅG Capisco Puls 8002 and 8020 are only available in the following fabrics: Nexus and Sprint (Camira) or Evida (skai by Hornschuch). Evida has delivery time as extended. Nexus and Sprint (Standard colours) and Evida (Extended colours) are price group 3. Nexus and Sprint in Extended colours are price group 4.

\*\* Must be ordered together with 200 or 265 mm lift

\*\*\* Pad available in all HTC Standard fabrics and leather except Steelcut Trio and Paloma leather



# HÅG Futu® - task chairs

- HÅG in Balance® (balanced, flowing tilt function backwards and forwards)
- Seat depth adjustment
- Adjustable lumbar support
- Seat height adjustment
- Adjustable forwards and backwards tilting resistance
- Lockable tilt
- Aluminium five star base (Ø730 mm) with foot supports, black or silver
- 165 mm lift (Seat height: 400-550 mm)
- Painted aluminum colours: black or silver
- Plastic colour: black

Item no	Base model +	Price Group							Price
1020-F	HÅG Futu 1020-F • FutuKnit on seat and face of backrest								17584
			①	②	③	④	⑤	⑥	Price
1020	HÅG Futu 1020 • Black or grey Futuknit only on face of backrest. HTC Standard on seat		17640	18032	18648	19404	20132	23128	

## Accessories/Options

Adjustable armrests, black plastic	1848
- Surcharge for armrests with black leather tops	2632
- Surcharge for armrests with 3D tops	1848
200 mm lift	560
Five star base (Ø680 mm) in black plastic	-672
Five star base in polished aluminium	2912
HÅG FootRing**	2968

\*\* Must be ordered together with 200 mm lift

# HÅG Futu® Communication

- Backward tilt
- Sledge base in steel (Seat height: 465 mm)
- Stackable (4 chairs)
- Painted aluminum colours: black or silver
- Plastic colour: black

Item no	Base model +	Price Group							Price
1070-F	HÅG Futu Communication 1070-F • FutuKnit								9408
			①	②	③	④	⑤	⑥	Price
1070	HÅG Futu Communication 1070 • Black or grey FutuKnit on backrest front and HTC Standard on seat		9800	9996	10500	11032	11788	13188	

## FutuKnit™ by Camira

FutuKnit is a fabric especially designed for the HÅG Futu precisely shaped and fitted for the back support and seat cushion. The 3D knitted fabric adjusts itself to the curvature of the body. It provides higher seating comfort through soft upholstery with no foam and no unnecessary seams and good resilient elasticity. Eight attractive and harmonious FutuKnit colours are available for the seat and back. (Please have a look and further information below). Otherwise you can select the seat fabric from the complete HÅG Total Colour program in combination with the back in black (FTU001) or grey (FTU002) FutuKnit. For further information please contact your HÅG dealer.

Composition:	100% polyester
Flammability:	BS EN 1021 – 1-2: 2006 (Cigarette & match), BS7176: 2007 Low Hazard
Fastness to rubbing:	Dry and Wet 4 (scale 1–5)
Weight (g/m <sup>2</sup> ):	Back: 766, Seat: 668
Abrasion:	>110 000 Martindale
Light fastness:	6 (scale 1–8)
Pilling:	5 (BS EN ISO 12945-2)
Maintenance:	To be vacuumed with a furniture brush or use a clean white damp cloth or sponge slightly dampened with clean lukewarm water.
Environmental facts:	Manufacturing process - fully compliant with ISO 14001. EU Ecolabel, Oeko-tex 100





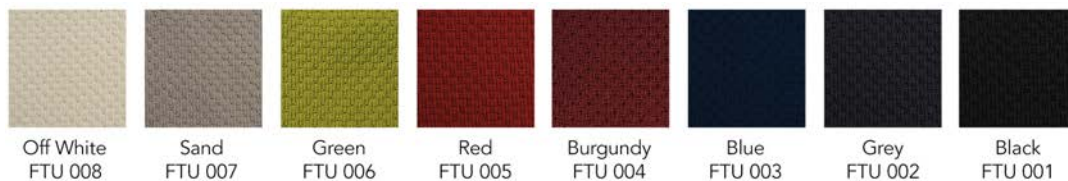

## Guarantee:

Flokk offers a 10 year guarantee against material defects and manufacturing faults from date of production on all chairs upholstered in FutuKnit and HTC Standard fabrics and leather.



# HÅG® Executive - task chairs

- HÅG in Balance® (balanced, flowing tilt function backwards and forwards)
- Adjustable forwards and backwards tilting resistance
- Seat height adjustment
- Seat depth adjustment
- Adjustable lumbar support on all models
- Adjustable headrest on model 9031, 9231 and 9331
- Tilt lockable in three positions
- HÅG TiltDown™ armrests (tilt down, height and width) with black leather top
- Five star base (Ø740 mm) with sloping footplates, in matt black aluminium
- All aluminium components are standard black. Optionally available in combinations with polished aluminium or all polished. Please specify colour at time for order. See page 15 for specifications
- 150 mm lift (Seat height: 397-525 mm)

Item no	Base model +	Price Group	①	②	③	④	⑤	⑥	Price
9031	HÅG Tribute 9031 • Headrest		50792	51884	53704	55832	57904	66584	
9021	<u>HÅG Tribute 9021</u>		43204	44128	45696	47488	49252	56644	
9221	HÅG Inspiration 9221 • Back in Space (dark) or Lumina (black) • Seat and cushion available in Note, Shimmer (PG 4) and Paloma Soft (PG 6)						43652	50652	
9231	HÅG Inspiration 9231 • Back with headrest in Space (dark) or Lumina (black) • Seat and cushions available in Note, Shimmer (PG 4) and Paloma Soft (PG 6)						53732	70308	
9321	HÅG Excellence 9321 • Rear of backrest is upholstered in black Plaintech • Seat and back available in Vadal Uni (PG 4) and Paloma Soft (PG 6)						52500	68908	
9331	HÅG Excellence 9331 • Back with headrest • Rear of backrest is upholstered in black Plaintech • Seat and back available in Vadal Uni (PG 4) and Paloma Soft (PG 6)						66948	87668	

**Accessories/Options**

All polished aluminium	5180
Mix of black / polished aluminium - Black foot base with polished details	1316
Mix of polished / black aluminium - Polished foot base with black details	3472
HÅG Executive Basic armrests (with height and width adjustment)	-3556
200 mm lift	448
Five star base (Ø740 mm), in polished aluminium	2436

# HÅG® Executive - Meeting chairs

- HÅG inBalance® (balanced, flowing tilt function backwards and forwards)
- Seat height adjustment
- Adjustable back cushion (lumbar)
- Swivel
- Adjustable tilting resistance backwards
- Five star base (Ø650 mm) with sloping footplates, in matt black aluminium
- All aluminium components are standard black. Optionally available in combinations with polished aluminium or all polished. Please specify colour at time for order. See page 15 for specifications

Item no	Base model +	Price Group	①	②	③	④	⑤	⑥	Price
9073	HÅG Tribute Meeting 9073		27944	28560	29568	30744	31864	36652	
9273	HÅG Inspiration Meeting 9273 <ul style="list-style-type: none"> <li>• Back in Space (dark) or Lumina (black).</li> <li>• Seat and cushion available in Note, Shimmer (PG 4) and Paloma Soft (PG 6)</li> </ul>						30520	34552	
9373	HÅG Excellence Meeting 9373 <ul style="list-style-type: none"> <li>• Rear of backrest is upholstered in black Plaintech</li> <li>• Seat and back available in Vadal Uni (PG 4) and Paloma Soft (PG 6)</li> </ul>						33348	45640	

## Accessories/Options

All polished aluminium	5180
Mix of black / polished aluminium - Black foot base with polished details	1316
Mix of polished / black aluminium - Polished foot base with black details	3472
HÅG Executive Basic armrests (with height and width adjustment)	6104
Five star base (Ø650 mm) in polished aluminium	2296
Four star base (Ø785 mm) in black painted aluminium	-504
Four star base (Ø785 mm) in polished aluminium	1596

## HÅG EXECUTIVE COLLECTION – ADDITIONAL INFORMATION

We offer 4 predefined configurations for the HÅG Executive range:



HÅG Tribute 9031

### ALL BLACK (standard)

- Black aluminium foot base – 1
- Black lift cover – 2
- Black armrests – 3
- Black lower part of armrests – 4
- Black lumbar wheel – 5
- Black ring/cover for lumbar wheel – 6
- Black Headrest stem cover – 8
- Black headrest stem – 7
- Black spine – 9
- Black upper and lower back bars – 10



HÅG Excellence 9321



HÅG Tribute 9031

### BLACK FOOTBASE WITH POLISHED DETAILS (option)

- Black aluminium foot base – 1
- Polished lift cover – 2
- Polished armrests – 3
- Polished ring/cover for lumbar wheel – 6
- Polished headrest stem cover – 8
- Black lower part of armrests – 4
- Black lumbar wheel – 5
- Black headrest stem – 7
- Black spine – 9
- Black upper and lower back bars – 10



HÅG Excellence 9321



HÅG Tribute 9031

### POLISHED FOOTBASE WITH DETAILS IN BLACK (option)

- Polished aluminium foot base – 1
- Black lift cover – 2
- Black lower part of armrests – 4
- Black lumbar wheel – 5
- Black headrest stem cover – 8
- Black spine – 9
- Polished armrests – 3
- Polished ring/cover for lumbar wheel – 6
- Polished headrest stem – 7
- Polished upper and lower back bars – 10



HÅG Inspiration 9221



HÅG Tribute 9031

### ALL POLISHED (option)

- Polished aluminium foot base – 1
- Polished lift cover – 2
- Polished armrests – 3
- Polished lumbar wheel – 5
- Polished ring/cover for lumbar wheel – 6
- Polished Headrest stem cover – 8
- Polished Headrest stem – 7
- Polished upper and lower back bars – 10
- Black lower part of armrests – 4
- Black spine – 9



HÅG Inspiration 9221

## HÅG EXECUTIVE ADDITIONAL INFORMATION – FABRICS

### PLAINTECH (SR-WEBATEX)

(used on the rear side of the backrest on HÅG Excellence 9321 and 9331 and HÅG Meeting Excellence 9373)

Composition: 100 % polyamide  
Flammability: BS EN 1021: 1–2 (Cigarette & match)

Space (dark) (Gabriel) and Lumina (K&R Sax)  
(used on the back of HÅG Inspiration 9221 and 9231 and HÅG Meeting Inspiration 9273). These innovative textiles are self-supportive, which gives new possibilities regarding product design as well as becoming an important part of the sitting experience.

### SPACE

Composition: 100 % polyester monofilament  
Abrasion and tear-strength: 2469N x 11083N support strength  
Flammability: BS EN 1021: 1–2 (Cigarette & match), FAR 25.853, DIN 4104 - B1 and B2, BS 5852 P 2 crib5  
Environmental facts: ISO 14001 certified  
Colour:

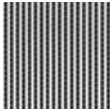

Space  
SPA 000

### LUMINA

Composition: 67% polyester, 33% polyamide  
Abrasion: >100 000 Martindale  
Tear-strength: 1457N x 1283N  
Flammability: BS EN 1021: 2006 (Cigarette)  
Environmental facts: ISO 14001 certified  
Colour:

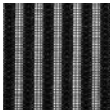

Black Lumina  
LUM 100









For all the above mentioned fabrics the following guarantee and maintenance apply:

Guarantee: 10 years, 5 years for 24/7 use.

Maintenance: To be vacuumed with a furniture brush, wiped with a clean damp cloth or sponge slightly dampened with clean lukewarm water.

# HÅG H05® - task chairs

- HÅG in Balance® (balanced, flowing tilt function backwards and forwards)
- 4 in 1 adjustment: seat depth, back height and forward and backward tilt tension in one wheel
- Adjustable seat height
- Possibility to adjust backrest separately
- Lockable in three positions
- Five star base (Ø730 mm) in aluminium with curved/arched footplates, standard in black or silver, optionally in polished aluminium.  
Please specify colour at time of order.
- 150 mm lift (Seat height: 390-515 mm)

Item no	Base model +	Price Group	①	②	③	④	⑤	⑥	Price
5100	HÅG H05 5100 • Partially upholstered • Low back		21840	22232	23396	24108	25340	28784	
5200	HÅG H05 5200 • Fully upholstered • Low back		23800	24304	25200	26264	27524	31276	
5300	HÅG H05 5300 • Partially upholstered • Medium back		23408	23940	25088	26348	27552	32060	
5400	HÅG H05 5400 • Fully upholstered • Medium back • Available as electro static discharged (ESD) chair. (PG 6 + 10%) • Headrest and armrests not available for ESD chair		25312	25788	27104	28308	29540	34552	
5500	HÅG H05 5500 • Partially upholstered • High back		24808	25368	26628	27804	28980	33880	
5600	HÅG H05 5600 • Fully upholstered • High back		26684	27272	28644	29904	31024	36344	



**Accessories/Options**



Headrest HÅG H05 5100, 5300, 5500	6020	6076	6328	6608	7280	7952	
Headrest HÅG H05 5200, 5400, 5600	6860	7056	7280	7560	8400	8932	
Adjustable armrest							3780
- Surcharge for armrests with leather tops (black standard)							3976
- Surcharge for armrests with 3D tops							1484
- Surcharge for HÅG SwingBack® armrests							2884
200 mm lift							308
265 mm lift (glides are recommended, no additional charge)							644
Five star base (Ø730 mm) in polished aluminium							3164
Decorative stitching*							2436
HÅG FootRing**							2968
HÅG StepUp							4200

\* Available for model 5200, 5400 and 5600. Please see HÅG Colour and Fabrics for additional information

\*\* Must be ordered together with 200 or 265 mm lift





# HÅG H05® Communication

- HÅG in Balance® (balanced, flowing tilt function backwards and forwards)
- Medium back
- Legs in aluminium, black or silver, optionally in polished aluminium. Please specify colour at time of order. (Seat height: 445 mm)
- Glides for hard or soft flooring need to be specified at time of order.

Item no	Base model +	Price Group	①	②	③	④	⑤	⑥	Price
5370	HÅG H05 5370 ● Partially upholstered ● Plastic glides		10948	11508	12628	13552	14812	16688	
5470	HÅG H05 5470 ● Fully upholstered ● Plastic glides		11788	12320	13860	15176	16380	18564	
<b>Accessories/Options</b>									
Armrests HÅG H05 Comm. 5370, 5470, black									1120
Polished legs									3780

# HÅG H04® - task chairs

- HÅG in Balance® (balanced, flowing tilt function backwards and forwards)
- Seat depth adjustment
- Back height adjustment
- Adjustable seat height
- Adjustable tilt tension forwards and backwards
- Lockable in three positions
- Five star base (Ø730 mm) in aluminium with footplates, standard in black or silver, optionally in polished aluminium. Please specify colour at time of order.
- 150 mm lift (Seat height: 395-530 mm)

Item no	Base model +	Price Group	①	②	③	④	⑤	⑥	Price
4100	HÅG H04 4100 <ul style="list-style-type: none"> <li>• Low back</li> <li>• Smaller seat than 4200 (5 mm width and 10 mm depth)</li> <li>• Available as electro static discharged (ESD) chair (PG 6 + 10%)</li> <li>• Headrest and armrests not available for ESD chair</li> </ul>		20944	21476	22400	23212	24528	27636	
4200	HÅG H04 4200 <ul style="list-style-type: none"> <li>• Low back</li> </ul>		23100	23520	24584	25564	26796	30436	
4400	HÅG H04 4400 <ul style="list-style-type: none"> <li>• Medium back</li> </ul>		24024	24640	25872	26992	28196	32900	
4600	HÅG H04 4600 <ul style="list-style-type: none"> <li>• High back</li> </ul>		26096	26684	28028	29288	30520	35672	
4650	HÅG H04 4650 <ul style="list-style-type: none"> <li>• Extra wide (40 mm wider than 4600)</li> </ul>		28056	28812	30100	31528	32732	38360	
<b>Accessories/Options</b>									
Headrest HÅG H04 4400, 4600, 4650			6860	7056	7280	7532	8400	9044	
Adjustable armrests									3836
- Surcharge for armrests with leather tops (black standard)									2772
- Surcharge for armrests with 3D tops									1512
200 mm lift									308
265 mm lift (glides are recommended, no additional charge)*									644
Five star base (Ø730 mm) in polished aluminium									3164
HÅG FootRing**									2968
HÅG StepUp									4200

\* 265 mm lift must be ordered together with five star base in aluminium

\*\* Must be ordered together with 200 or 265 mm lift

# HÅG H04® Communication

- HÅG in Balance® (balanced, flowing tilt function backwards and forwards)
- Glides for hard or soft flooring need to be specified at time of order.

Item no	Base model +	Price Group	①	②	③	④	⑤	⑥	Price
4470	HÅG H04 4470 <ul style="list-style-type: none"> <li>• Sledge base in steel: black or silver (Seat height: 445 mm)</li> </ul>		11984	12544	14168	15456	17192	18928	
4472	HÅG H04 4472 <ul style="list-style-type: none"> <li>• Adjustable seat height</li> <li>• Aluminium 5 star base (Ø730 mm) w/footplates: black or silver</li> <li>• 150 mm lift (Seat height: 375-515 mm)</li> </ul>		12852	13524	15204	16436	18284	20076	

## Accessories/Options

Armrests in aluminium. Silver or black.

2268

# HÅG H03® - task chairs

- HÅG in Balance® (balanced, flowing tilt function backwards and forwards)
- Seat height adjustment
- Combined adjustment of back height and seat depth
- Five star base (Ø686 mm) in plastic with sloping footplates
- 150 mm lift (Seat height: 412-551 mm)

Item no	Base model +	Price Group	①	②	③	④	⑤	⑥	Price
330	HÅG H03 330 <ul style="list-style-type: none"> <li>• Low back</li> <li>• Removable upholstery on seat and back (low)</li> <li>• Back bar and arm slides in black or silver</li> </ul>		14476	14728	15288	16016	16940	19068	
340	HÅG H03 340 <ul style="list-style-type: none"> <li>• Removable upholstery on seat and back (medium)</li> <li>• Individual tilt tension adjustment</li> </ul>		16016	16324	17108	17696	18620	21084	
350	HÅG H03 350 <ul style="list-style-type: none"> <li>• Fully upholstered seat and back (medium)</li> <li>• Individual tilt tension adjustment</li> </ul>		18396	18788	19628	20412	21336	24220	

## Accessories/Options

Adjustable armrests	2100
200 mm lift	420
265 mm lift (glides are recommended, no additional charge)*	756
Telescopic lift cover	364
Five star base (Ø730 mm) in aluminium - silver/black	924
Five star base (Ø730 mm) in polished aluminium	4396
HÅG FootRing**	2968
Five star base (Ø680 mm) in black plastic	0

\* 265 mm lift must be ordered together with five star base in aluminium







\*\* Must be ordered together with 200 or 265 mm lift

# HÅG Conventio® - conference chairs

- HÅG in Balance® (balanced, flowing tilt function backwards and forwards)
- Black or silver coloured backstems, must be specified at time of order for models 9512 and 9522

The following applies for models 9510, 9511, 9520 and 9521:

- Legs in black or silver aluminum. Please specify colour at time of order
- Stackable (15 chairs), only available for 4 legged models
- Glides for hard or soft flooring need to be specified at time of order

Item no	Base model +	Price Group	①	②	③	④	⑤	⑥	Price
9510	HÅG Conventio 9510 ● Upholstered seat and backrest front (plastic back) ● Removable upholstery ● Built-in handle for carrying ● Seat height: 455 mm		9016	9184	9604	10136	11200	14728	
9511	HÅG Conventio 9511 ● As 9510 above ● 4 cm wider than 9510 ● Seat height: 450 mm		9940	10192	10640	11116	12348	16184	
9512	HÅG Conventio 9512 ● 5 star plastic foot base (Ø635 mm) ● 150 mm lift (Seat height: 400-540 mm) ● Backstems in black or silver		11284	11480	12040	12572	13804	18368	
9520	HÅG Conventio 9520 ● Upholstered seat and back ● Removable upholstery ● Seat height: 455 mm		9492	9688	10136	10640	11480	15176	
9521	HÅG Conventio 9521 ● As 9520 above ● 4 cm wider than 9520 ● Seat height: 450 mm		10444	10668	11088	11536	12656	16604	
9522	HÅG Conventio 9522 ● 5 star plastic foot base (Ø635 mm) ● 150 mm lift (Seat height: 400-540 mm) ● Backstems in black or silver		11900	12152	12544	13216	14336	18900	

**Accessories/Options**

	Armrest in plastic	1456
165240	HÅG Writing tablet. Black, right-handed. Fold down tablet for storage and stacking of chair. (Only for: 9510, 9511, 9520, 9521)	1960
165242	HÅG Writing tablet. Black, right-handed + Armrest in plastic, left side. (Only for: 9510, 9511, 9520, 9521)	2772
	Five star base (Ø730 mm) in aluminium - silver/black (Only for: 9512, 9522)	924
	Five star base (Ø730 mm) in polished aluminium (Only for: 9512, 9522)	4088
115805	Chair hanger. Must be specified at time of order. Can not be retrofitted*	1372
115806	Chair hanger. Must be specified at time of order. Can not be retrofitted	1372
	Connection device - only available for 4 legged models (Only for: 9510, 9511, 9520, 9521)	168
149201	Chair trolley (10 chairs)	5488
108984	HÅG SlipCover available in Atlantic (Gabriel) off-white or grey (Only for: 9510, 9520)	2128







\* For models 9512 and 9522.



108984

# HÅG Conventio Wing® - conference chairs

- HÅG in Balance® (balanced, flowing tilt function backwards and forwards)
- 9811, 9821, 9831: 4 legs and backstems in matt black or silver coloured aluminium.
- Please specify colour at time of order.
- 9812, 9822, 9832: 5 star foot base in black plastic. 150mm gaslift.
- Seat and backrest available in 6 different colours: Clay, Sea Green, Petroleum, Black, White and Red.
- Stackable: 15 chairs (4 legged models)
- Glides for hard or soft flooring need to be specified at time of order.

Item no	Base model +	Price Group						Price
9811	HÅG Conventio Wing 9811 ● Plastic seat and back ● Seat height: 430 mm							5824
9812	HÅG Conventio Wing 9812 ● Plastic seat and back ● 5 star plastic foot base (Ø635 mm) ● Backstems in matt black or silver ● Seat height: 375-515 mm							7532
			①	②	③	④	⑤	Price
9821	HÅG Conventio Wing 9821 ● Removable upholstery on seat ● Plastic back ● Seat height: 430 mm		7308	7448	8148	8904	9268	
9822	HÅG Conventio Wing 9822 ● Removable upholstery on seat ● Plastic back ● 5 star plastic foot base (Ø635 mm) ● Backstems in matt black or silver ● Seat height: 380-520 mm		9016	9212	10136	11004	11396	
9831	HÅG Conventio Wing 9831 ● Removable upholstery on seat and back ● Seat height: 430 mm		8960	9100	9968	10836	11284	
9832	HÅG Conventio Wing 9832 ● Removable upholstery on seat and back ● 5 star plastic foot base (Ø635 mm) ● Backstems in matt black or silver ● Seat height: 380-520 mm		10640	10836	11900	13020	13524	







**Accessories/Options**

	Armrest in plastic	1456
165240	HÅG Writing tablet. Black, right-handed. Fold down tablet for storage and stacking of chair. (Only for: 9811, 9821, 9831)	1960
165242	HÅG Writing tablet. Black, right-handed + Armrest in plastic, left side. (Only for: 9811, 9821, 9831)	2772
	Five star base (Ø730 mm) in aluminium - silver/black (Only for: 9812, 9822, 9832)	924
	Five star base (Ø730 mm) in polished aluminium (Only for: 9812, 9822, 9832)	4088
165243	Chair suspension for HÅG Conventio Wing only. To be mounted on the underside of a table top.	283
115805	Chair hanger. Must be specified at time of order. Can not be retrofitted*	1372
115806	Chair hanger. Must be specified at time of order. Can not be retrofitted	1372
	Connection device - only available for 4 legged models (Only for: 9811, 9821, 9831)	168
149201	Chair trolley (10 chairs)	5488

\* For models 9812, 9822 and 9832.

# HÅG Accessories

Item no	Base model +	Price Group	Price
165177-1A/2A	<p>HÅG StepUp</p> <ul style="list-style-type: none"> <li>● Black (1A) or silver (2A)</li> <li>● Two extra levels for your feet</li> <li>● Greater variety of seating positions</li> <li>● Easy to attach and detach</li> <li>● For use with 150, 200 and 265 mm gas lifts</li> <li>● Suits desk heights of 80-95 cm</li> </ul>		4200
165178-1A/2A	<p>HÅG StepUp</p> <ul style="list-style-type: none"> <li>● Two pack, black or silver</li> </ul>		8344
165134	<p>HÅG QuickStep</p> <ul style="list-style-type: none"> <li>● Tilting footrest, stimulates circulation</li> <li>● Foot massager</li> <li>● Balance training</li> </ul>		3192
165129	<p>HÅG QuickStep</p> <ul style="list-style-type: none"> <li>● Six pack</li> </ul>		18816
169121	<p>HÅG FootRing</p> <ul style="list-style-type: none"> <li>● Black, silver or white</li> <li>● Additional height for the feet to rest on</li> <li>● Compatible with all HÅG task chairs (except HÅG H09) with 200 or 265 mm gas lifts</li> </ul>		2968
149201	<p>Chair trolley (10 chairs)</p> <ul style="list-style-type: none"> <li>● Trolley for moving HÅG Conventio and HÅG Conventio Wing with 4 legs only</li> <li>● Recommended for max 8 pcs</li> <li>● Black</li> </ul>		5488

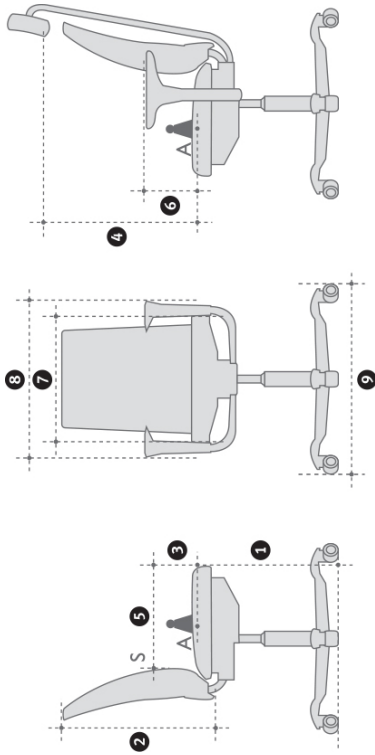

## Physical measurements for HÅG working chairs

Measurements in mm. **A** mid-point of chair, loaded with 64 Kg. **S** foremost point of back pads, reference point for measurement of back support adjustment

Model	Seat height, measured with 64 kg load						7	8	9	Weight of chair in kg		
	165 mm lift	150 mm lift	200 mm lift	265 mm lift	2	3					4	5
<b>HÅG Sofi</b>	Tilt range is 20° forwards and 14° backwards from a neutral position 4° to the rear											
HÅG SoFi 7200	395-545	450-640	450-640	620	165-260	630-835	385-445	185-300	450	600-715	730	17,3
HÅG SoFi 7300	395-545	450-640	450-640	720	165-260	630-835	385-445	185-300	450	600-715	730	17,5
HÅG SoFi 7500	395-545	450-640	450-640	720	165-260	630-835	380-460	185-300	450	600-715	730	17,0
<b>HÅG Capisco</b>	Tilt range is 15° backwards from a neutral position 2° to the rear.											
HÅG Capisco 8105	380-515	445-630	530-790				470		470	730	730	7.5
HÅG Capisco 8106	408-540	470-655	555-810	460	150-240		340-420		470	730	730	14.0
HÅG Capisco 8126	408-540	470-655	555-810	460	150-240		340-420		470	730	730	14.5
HÅG Capisco 8107	408-540	470-655	555-810	460	150-240	555-785	340-420		470	730	730	15.5
HÅG Capisco 8127	408-540	470-655	555-810	460	150-240	555-785	340-420		470	730	730	16.0
<b>HÅG Capisco Puls</b>	Tilt range is 15° backwards from a neutral position 2° to the rear.											
HÅG Capisco Puls 8001	365-500	455-620	540-770				460		460	730	730	7.0
HÅG Capisco Puls 8002	375-515	470-635	555-785				460		460	730	730	7.0
HÅG Capisco Puls 8010	390-525	455-640	540-795	400	140-230		400-470		460	565	730	11.1
HÅG Capisco Puls 8020	400-535	470-650	555-805	400	130-220		400-470		460	565	730	11.1
<b>HÅG Futu</b>	Tilt range is 20° forwards and 14° backwards from a neutral position 4° to the rear.											
HÅG Futu 1020	400-550	450-640	580	160-255	385-465	195-290	470	610-700	730	730	16.8	

\* According to EN1335 Class A  
Please note that these measurements are not absolute. They may vary slightly from chair to chair.

Model	Seat height, measured with 64 kg load				2	3	4	5	6	7	8	9	Weight of chair in kg
	165 mm lift	150 mm lift*	200 mm lift	265 mm lift									
<b>HÅG Executive</b>	Tilt range is 7° forwards and 18° backwards from a neutral position 3° to the rear												
HÅG Tribute 9021	408-518		462-637		740	170-238		395-480	178-285	455	495-675	740	25.0
HÅG Tribute 9031	408-518		462-637		740	170-238		395-480	178-285	455	495-675	740	25.0
HÅG Inspiration 9221	405-535		455-645		780	165-255		395-480	200-300	455	495-675	740	20.0
HÅG Inspiration 9231	405-535		455-645		1060	165-255		395-480	200-300	455	495-675	740	21.5
HÅG Excellence 9321	405-535		455-645		780	165-255		395-480	200-300	455	495-675	740	19.5
HÅG Excellence 9331	405-535		455-645		1060	165-255		395-480	200-300	455	495-675	740	22.0
<b>HÅG H05</b>	Tilt range is 15° forwards and 16° backwards from a neutral position 1° to the rear.												
HÅG H05 5100	390-515		465-645	550-785	415	135-250		385-480	175-280	450	600-700	730	12.5
HÅG H05 5200	390-515		465-645	550-785	410	135-250		385-480	175-280	450	600-700	730	13.0
HÅG H05 5300	390-515		465-645	550-785	475	135-250		385-480	175-280	450	600-700	730	16.0
HÅG H05 5400	390-515		465-645	550-785	470	135-250		385-480	175-280	450	600-700	730	16.5
HÅG H05 5500	390-515		465-645	550-785	555	135-250		385-480	175-280	450	600-700	730	18.0
HÅG H05 5600	390-515		465-645	550-785	550	135-250		385-480	175-280	450	600-700	730	19.0
<b>HÅG H04</b>	Tilt range is 11° forwards and 16° backwards from a neutral position 4° to the rear												
HÅG H04 4100	395-530		460-640	550-785	465	165-255		360-455	200-300	425	580-680	730	13.5
HÅG H04 4200	395-530		465-645	555-790	465	170-260		390-485	200-300	430	580-680	730	12.8
HÅG H04 4400	395-530		465-645	555-790	510	170-260		390-485	200-300	430	580-680	730	15.6
HÅG H04 4600	395-530		465-645	555-790	590	170-260		390-485	200-300	430	580-680	730	15.8
HÅG H04 4650	395-530		465-645	555-790	595	170-260		390-485	190-275	475	580-680	730	16.0
<b>HÅG H03</b>	Tilt range is 12° forwards and 10° backwards from a neutral position 0°.												
HÅG H03 330	412-551		520-700	548-783	300	170-240		400-470	165-285	420	630	686	12.0
HÅG H03 340	412-551		520-700	548-783	410	165-235		400-470	165-285	420	630	686	12.0
HÅG H03 350	412-551		520-700	548-783	430	160-230		400-470	165-285	445	630	686	13.0

\* According to EN1335 Class A  
Please note that these measurements are not absolute. They may vary slightly from chair to chair.

## Physical measurements for HÅG meeting and conference chairs

All measurements in mm. Where a chair is adjustable, minimum and maximum measurements are listed.

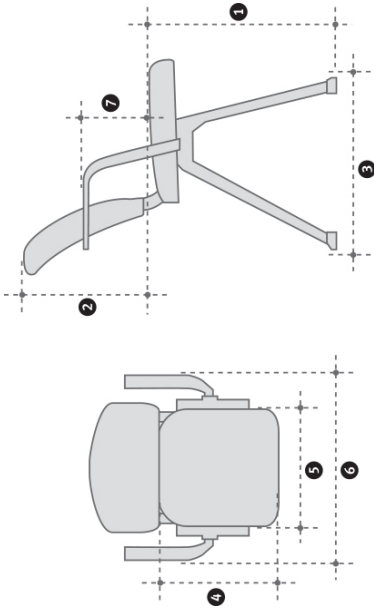

Model	1 Seated height, measured with 64 kg load	2 Back height (mm)	3 Diam. footbase (mm)	4 Seat depth (mm)	5 Seat width (mm)	6 Chair width (mm)	7 Armrests (mm)	8 Weight (kg)	Tilt range		
									Neutral	Forwards	Backwards
HÅG SoFi Comm. 7202	400-550	620	785	380-460	450	600		16.2*	-2°	11°	13°
HÅG SoFi Comm. 7302	400-550	720	785	380-460	450	600		16.7*	-2°	11°	13°
HÅG SoFi Comm. 7502	400-550	720	785	380-460	450	600		15.7*	-2°	11°	13°
HÅG Futu Comm. 1070	465	460	-	460	465	550	215	9.3	-	-	-
HÅG Tribute Meeting 9073	408-518	530	650	430	455	600-680 (740) 1)	155-265	19.2*	-4°	3°	13°
HÅG Inspiration Meeting 9273	385-520	570	650	440	455	600-680 (740) 1)	155-265	16.0 13.0*	-4°	4°	13°
HÅG Excellence Meeting 9373	385-520	570	650	435	455	600-680 (740) 1)	155-265	16.5 13.5*	-4°	4°	13°
HÅG H05 Comm. 5370	445	460	-	415	445	570 *470	235	7.2	-4°	9°	13°
HÅG H05 Comm. 5470	445	460	-	415	445	570 *470	235	7.2	-4°	9°	13°
HÅG H04 Comm. 4470	445	510	-	425	450	600 *480	210	10.2	-5°	9°	13°
HÅG H04 Comm. 4472	375-515	510	730	425	450	600 *480	210	9.1	-5°	9°	13°

1) Max. diagonal diameter

\* Measurements without armrests

Please note that the measurements are not absolute. They may vary slightly from chair to chair.

# Physical measurements for HÅG meeting and conference chairs

All measurements in mm. Where a chair is adjustable, minimum and maximum measurements are listed.

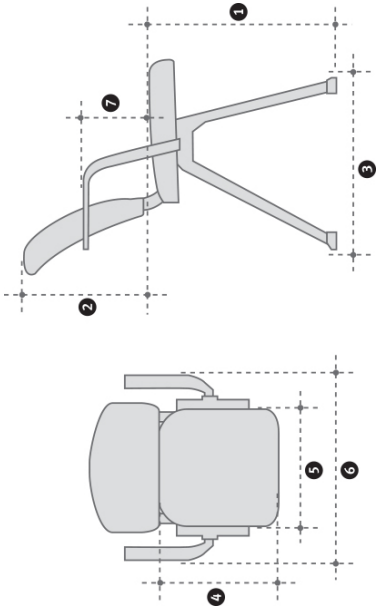

Model	1 Seated height, measured with 64 kg load	2 Back height (mm)	3 Diam. footbase (mm)	4 Seat depth (mm)	5 Seat width (mm)	6 Chair width (mm)	7 Armrests (mm)	8 Weight (kg)	Tilt range		
									Neutral	Forwards	Backwards
HÅG Conventio 9510, 9520	455	390	-	425	390	550 *460	230	5.0	-5°	12°	11°
HÅG Conventio 9511, 9521	450	460	-	430	430	590 *500	230	5.9	-5°	12°	11°
HÅG Conventio 9512, 9522	400-540	460	635	430	430	550 *460	230	8.3	-5°	12°	11°
HÅG Conventio Wing 9811/9841	430	380	-	420	430	600 *500	245	5.2 *4.4	-5°	12°	11°
HÅG Conventio Wing 9821	430	380	-	420	430	600 *500	245	5.4 *4.6	-5°	12°	11°
HÅG Conventio Wing 9831	430	380	-	420	430	600 *500	245	5.6 *4.8	-5°	12°	11°
HÅG Conventio Wing 9812	375-515	380	635	420	430	600 *465 (635) 1)	245	7.6 *6.8	-5°	12°	11°
HÅG Conventio Wing 9822	380-520	380	635	420	430	600 *465 (635) 1)	245	7.8 *7.0	-5°	12°	11°
HÅG Conventio Wing 9832	380-520	380	635	420	430	600 *465 (635) 1)	245	8.0 *7.2	-5°	12°	11°

1) Max. diagonal diameter

\* Measurements without armrests

Please note that the measurements are not absolute. They may vary slightly from chair to chair.

## Tests and Certificates

Environmental information	HAG SoFi	HAG Capisco 8106	HAG Capisco Puls	HAG Futu	HAG Inspiration 9231	HAG H05 5300	HAG H05 5370	HAG H04 4400	HAG H04 4470	HAG H03 320	HAG Conventio 9511	HAG Conventio Wing 9520
EPD (Environmental Product Declaration)	Yes	Yes	Yes	Yes	Yes	Yes	Yes	Yes	Yes	Yes	Yes	Yes
Environmental key indicators (from EPDs):	92	36	31	51	60	61	37	53	54	44	34	24
• Global warming (kg CO <sub>2</sub> - equivalent)												
• Energy consumption (MJ)	1967	747	607	943	1370	1127	554	1021	900	786	396	397
• Amount of recycled material	45 %	43 %	48 %	33 %	46 %	37 %	34 %	39 %	21 %	32 %	29 %	26 %
• Amount of recyclable material	95 %	95 %	95 %	96 %	96 %	98 %	95 %	97 %	98 %	98 %	92 %	98 %
Nordic Eco Label (Swan)	Pending	Yes *									Yes	
GREENGUARD indoor climate certificate	Yes	Yes	Yes	Yes	Yes	Yes	Yes	Yes	Yes	Yes	Yes	Yes
ISO 1716 (Calorific value)	Yes											

An EPD (Environmental Product Declaration) is a document that summarises a product's environmental performance. An EPD is based on a life cycle assessment (LCA). The requirements for how an EPD is to be made are specified in the ISO 14025 standard. These standardised methods ensure that environmental information can be compared product by product, regardless of manufacturer, region or country. The GREENGUARD Indoor Air Quality Certification Program gives assurance that products designed for use in office environments and other indoor spaces meet strict chemical emissions limits, which contribute to the creation of healthier interiors.

\* Chair upholstered in Fame

# Tests and Certificates

Product tests	HAG SoFi	HAG SoFi Comm.	HAG Capisco	HAG Capisco Puls	HAG Futu	HAG Futu Comm.	HAG Executive	HAG Executive Meeting	HAG H05	HAG H05 Comm.	HAG H04	HAG H04 Comm.	HAG H03	HAG Conventio Wing	HAG Conventio	HAG Conventio Wing	HAG Tablet Arm
Ansi/Bifma (US)	Yes		Yes	Yes	Yes	Yes	Yes	Yes	Yes	Yes	Yes	Yes	Yes	Yes	Yes	Yes	Yes
EN 1335 Class A	Yes		Yes	Yes	Yes		Yes		Yes		Yes		Yes <sup>1</sup>				
EN 16139 (EN 13761)		Yes		Yes		Yes		Yes		Yes		Yes			Yes (Yes <sup>1</sup> )	(Yes <sup>1</sup> )	Yes
GS (DE)	Yes	Yes	Yes	Yes	Yes	Yes	Yes	Yes	Yes	Yes	Yes	Yes	Yes	Yes	Yes	Yes	Yes
BS 5459 (GB)	Yes *				Yes		Yes		Yes		Yes		Yes				
NPR 1813 (NL)	Yes w/3D armrest				Yes w/3D armrest				Yes		Yes						
EN 1729																	
Möbelfakta (SE)	Yes		Yes	Yes	Yes		Yes		Yes						Yes	Yes	
CAL TB 133			Yes	Yes											Yes	Yes	
CAL TB 117			Yes														

Certain assumptions have been taken. For more accurate information, please contact Customer Service Flokk.

<sup>1</sup> Without arm rests, ( ) Model with star base, \*) Q4, 2017

**Flokk's quality and environmental directives are certified according to ISO 9001, ISO 14001 and EMAS.**



# HÅG Total Colour Extended Collection

## With minimum 5 year guarantee

If you cannot find what you are looking for in our HÅG Total Colour Standard collection, we offer a comprehensive range in our HÅG Total Colour Extended collection. We offer a 10 year guarantee on Xtreme, Fame, Capture, Sirdal & Suldal, Paloma, Steelcut Trio 3, Nexus, Comfort+ and Vadal Uni. For more details on our guarantee please see page 4. Delivery time from factory on Extended fabrics is usually 25 - 30 working days provided fabric is available from our suppliers stock.

## Supplier / Collection

### Bogesunds Väveri - [www.bogesunds.se](http://www.bogesunds.se)

	Price group
Breeze	5
Global ESD	Price on request
Liv	4
Rain	5

### Bute - [www.butefabrics.com](http://www.butefabrics.com)

	Price group
Tweed	4

### Camira Fabrics - [www.camirafabrics.com](http://www.camirafabrics.com)

	Price group
24/7+	3
24/7 Flax	3
Blazer	3
Era	3
Hemp	3
Main Line Flax	3
Nexus (non standard)	4
Oxygen	3
Patina	3
Rivet	3
Sprint (non-std for HÅG Capisco Puls & HÅG Conventio Wing)	3
Synergy	3
Urban	3
X2	3
Xtreme (non standard)	3

### Gabriel - [www.gabriel.dk](http://www.gabriel.dk)

	Price group
Breeze	3
Breeze Fusion	4
Capture	4
Comfort+ (non standard)	5
Crisp	3
Criss Cross	4
Elevation	3
Fame (non standard)	3
Gaja C2C	4
Gaja Classic	3
Interglobe Wool 2	3
Note (non standard)	4
Novo 2	3
Repetto	3
Step	3
Step Melange	3
Swing	4

### GU - [www.gu.no](http://www.gu.no)

	Price group
Amdal	4
Bardal	3
Gandal	4
Heidal	3
Hemsedal	5
Jostedal	3
Lodal	3
Modal	4
Modal Mouline	4
Modal Point	4
Setesdal	4
Sirdal (non standard)	4
Suldal (non standard)	4
Vadal	4
Vadal Uni (non standard)	4

### Hornschuch - [www.skai.com](http://www.skai.com)

	Price group
Etano	3
Evida (not available for HÅG Capisco Puls 8001,8010)	3

### Kvadrat - [www.kvadrat.dk](http://www.kvadrat.dk)

	Price group
Canvas	4
Clara 2	3
Divina 3	5
Divina Melange 2	5
Divina MD	5
Fiord	4
Foss	4
Galaxy	5
Hallingdal 65	4
Molly 2	4
Pro 3	4
Remix 2	4
Rime	4
Steelcut 2	4
Steelcut Trio 3 (non standard)	4
Tonus 4	4
Tonus Meadow	4

### Ludvig Svensson - [www.ludvigsvensson.com](http://www.ludvigsvensson.com)

	Price group
Balance	5
Brink	4
Era	4
Flex	4
Ink	4
Khaki	3
Moss	5
Raw	5
Rock	4
Step	4

# HÅG Total Colour Extended Collection

## **Spradling - [www.spradlingvinyl.eu](http://www.spradlingvinyl.eu)**

Dolce 4

Valencia 3

## **Wollsdorf - [www.wollsdorfleather.com](http://www.wollsdorfleather.com)**

Paloma Price on request

## **Elmo - [www.elmoleather.com](http://www.elmoleather.com)**

Elmosoft Piqué(non std) Price on request

## **Nevotex - [www.nevotex.se](http://www.nevotex.se)**

Antistatic synthetic leather 3

## **Oniro - [www.oniro.nl](http://www.oniro.nl)**

Puxx 1 3

Puxx 2 3

# HÅG Colour and Fabrics

## Decorative stitching

Decorative stitching can truly add the little extra to your chair.

The 10-colour thread program is available on all textiles for the following HÅG chairs:

HÅG Capisco model 8105, 8106 and 8107

HÅG SoFi collection

HÅG H05 model 5200, 5400, 5600 and headrest

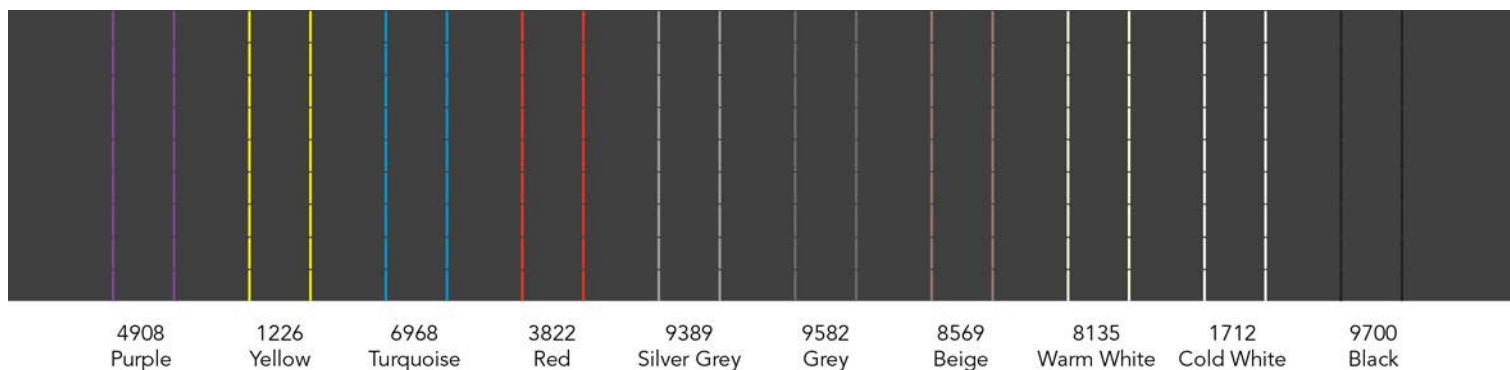

## FutuKnit™ (Camira Fabrics)

FutuKnit is a fabric especially designed for the HÅG Futu precisely shaped and fitted for the back support and seat cushion. The 3D knitted fabric adjusts itself to the curvature of the body. It provides higher seating comfort through soft upholstery with no foam and no unnecessary seams while maintaining good resilient elasticity. HÅG Futu 1020-F is only available in Futuknit. 8 colours listed below are available. HÅG Futu 1020 comes with FutuKnit on the backrest face, available in Grey (FTU002) or Black (FTU001) while the seat colour can be chosen from the HÅG Total Standard Colour program. For further information please contact your HÅG dealer.

Composition:	100% polyester
Abrasion:	> 110 000 Martindale
Flammability:	BS EN 1021 – 1-2: 2006 (Cigarette & match), BS7176: 2007 Low Hazard
Colour fastness to rubbing:	Dry and Wet 4 (scale 1–5)
Weight (g/m <sup>2</sup> ):	Cover. Model 1020. Back: 231 g Seat: 188 g Model 1070. Back: 184 g Seat: 176 g
Light fastness:	6 (scale 1–8)
Pilling:	5 (BS EN ISO 12945-2)
Environmental facts:	EU Ecolabel, Oeko-Tex® Standard 100, 100% free of heavy metals, ISO 14001 (company)

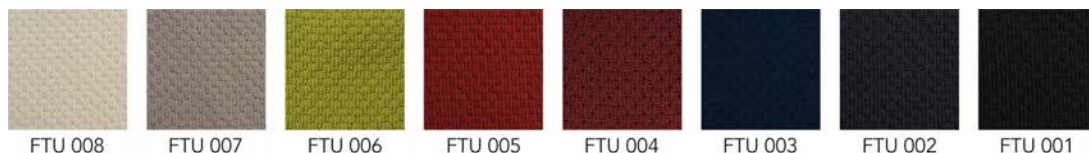

## HÅG Capisco Puls Plastic Colours



## HÅG Conventio Wing Plastic Colours



## Sprint (Camira Fabrics) - Price group 3

Sprint is a classic stretch knit fabric made from 100% polyester. A smooth cellular construction with a subdued finish gives a minimalistic and light expression. **Sprint is only available for HÅG Capisco Puls & HÅG Conventio Wing.**

Composition:	100% polyester
Abrasion:	> 100 000 Martindale
Flammability:	BS EN 1021: 1&2 (Cigarette & match), BS 7176: 2007 Low Hazard, UNI 9176 Class 1 IM, UNI 9175 Klasse 1 IM, CA TB 117-2013
Light fastness:	6 (ISO 105-B02)
Pilling:	4/5 (BS EN ISO 12945-2)
Environmental facts:	100% free of heavy metals, ISO 14001 certified (company)

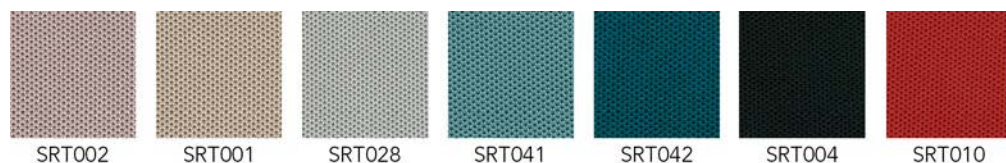

## Mesh (Palmhive)

A warp knitted heavy duty mesh, using an innovative yarn construction to give increased strength which provides enhanced comfort, support and appearance. Its structure is soft and comforting with a semi-transparent effect. The mesh is available in black and light grey. Easy to combine with many fabrics and colours from the HTC collection. **Mesh by Palmhive is only available for the back of HÅG SoFi mesh.**

Composition:	100% polyester
Abrasion resistance:	150.000
Flammability:	BS EN 1021: 1 -2: 2014
Pilling:	4-5 (EN-ISO 12945-2)
Environmental facts:	Oeko-Tex® Standard 100



# HÅG Total Colour Standard collection

– with 10 year guarantee as standard or 5 year guarantee on 24/7 use

HÅG Total Colour (HTC) Standard is our collection of fabrics, leather and other materials. The collection has been designed to bring out the best visual and functional qualities of these materials. All fabrics and leather in our Standard collection are of excellent quality. We offer short delivery times, a wide range and all our materials comply with strict environmental requirements.

Delivery time from factory is 15-20 working days after order has been registered. Transport days to be added.

Maintenance: Please vacuum with a furniture brush then use a clean cloth or sponge slightly dampened with clean lukewarm water.

Please note that colours shown in these illustrations may vary from the actual colours. Please contact your local HÅG supplier to view a sample.

## Xtreme (Camira Fabrics) - Price group 1

Xtreme is a crêpe fabric made from 100% recycled polyester that features exceptional Euro flammability performance. Extra stretch and structure gives an irregular, shiny finish.

Composition:	100% recycled polyester
Abrasion resistance:	100 000 Martindale
Flammability:	BS EN 1021: 1–2 (Cigarette & match), BS 7176 Low & Medium Hazard, BS 5852 Section 4 Crib 5, DIN 4102 B1, UNI 9175 Class 1
Light fastness:	6 (ISO 105 - B02: 2013)
Pilling:	5 (BS EN ISO 12945-2)
Environmental facts:	EU Ecolabel, Oeko-Tex® Standard 100, 100% free of heavy metals

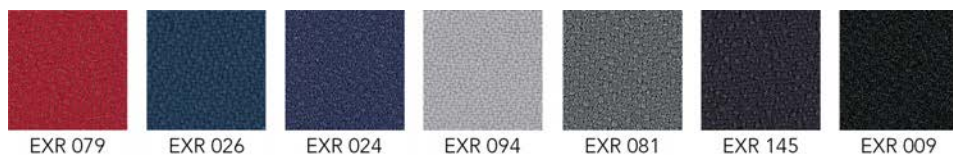

## Fame (Gabriel) - Price group 2

Fame is a tightly woven fabric of worsted wool and polyamide, combining excellent durability and incredible softness.

Composition:	95% wool, 5% polyamide
Abrasion resistance:	200 000 Martindale
Flammability:	BS S EN 1021: 1–2, BS 5852, Crib 5, Calif. Bull. 117-2013, IMO MSC 307(88) Annex 1 part 8, NFP 92-503:M2 (Zirpro), ÖNORM B 3825-B1-3800-Q1 UK (Flován)
Light fastness:	5-7 (EN ISO 105 - B02)
Pilling:	4 (BS EN ISO 12945-2)
Environmental facts:	EU Ecolabel, Oeko-Tex® Standard 100, 100% free of heavy metals

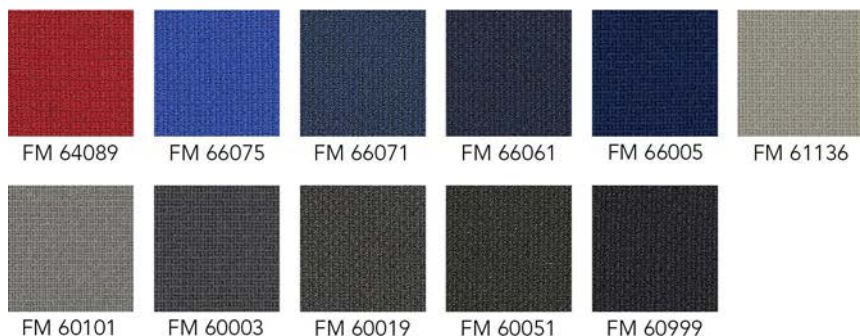

## Capture (Gabriel) - PG 3

Capture is a lightly felted and multi-coloured wool fabric combining softness, stretch and strength. It fuses light and dark colours to a refined melange pattern in subtle nuances, which add richness and depth to the design.

Composition:	85% wool, 15% polyamide
Abrasion resistance:	200 000 Martindale
Flammability:	BS EN 1021: 1-2, BS 5852 Part 1 0,1 (Cigarette & match), Calif. Bull. 117-2013
Light fastness:	5-7 (EN ISO 105-B02)
Pilling:	4-5 (EN-ISO 12945-2)
Environmental facts:	EU Ecolabel, Oeko-Tex® Standard 100, 100% free of heavy metals

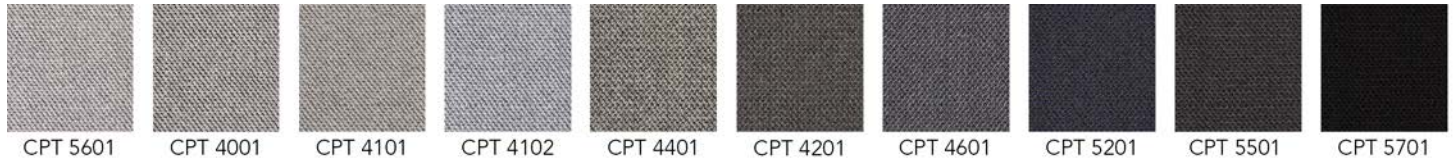

## Nexus (Camira Fabrics) - Price group 3

Nexus is a polyester knit in a sleek and stylish pinprick dot matrix design effect giving a granulated structured surface. The black yarn foundation highlights the structured surface in combination with fresh but subtle colours.

Composition:	100% polyester
Abrasion resistance:	100 000 Martindale
Flammability:	BS EN 1021: 1-2 (Cigarette & match), BS 7176 Low Hazard
Light fastness:	5 (ISO 105 - B02: 2013)
Pilling:	4/5 (BS EN ISO 12945-2)
Environmental facts:	100% free of heavy metals, Manufacturing process - fully compliant with ISO 14001

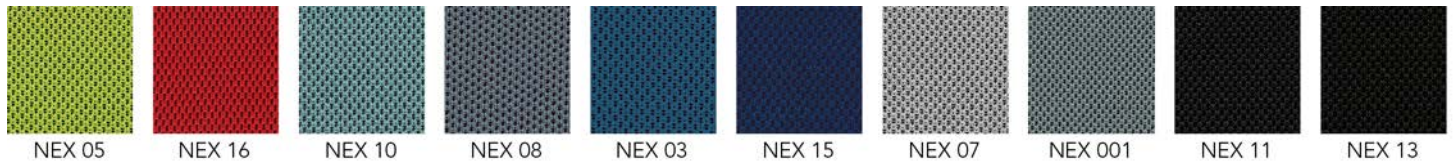

## Note (Gabriel) - Price group 3

Note is a soft and noble fabric which, with its classic satin structure, allows the wool's natural lustre to shine and impress.

Composition:	85% worsted wool, 15% polyamide
Abrasion resistance:	200 000 Martindale
Flammability:	EN 1021 1&2, BS 5852 0&1, BS 5852 crib 5, IMO 307 (88) Annex 1 part 8, IMO MSC 307(88) Annex 1 part 8, Calif. Bull. 117-2013
Light fastness:	5-8
Pilling:	4 (BS EN ISO 12945-2)
Environmental facts:	EU Ecolabel, Oeko-Tex® Standard 100, 100% free of heavy metals, Manufacturing process - fully compliant with ISO 14001

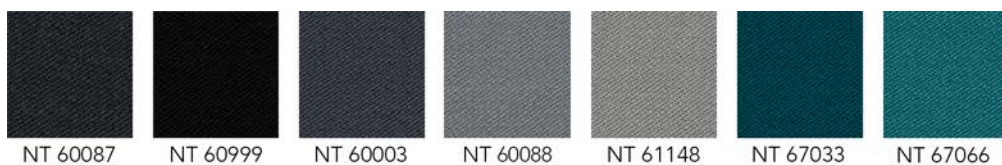



## Patina (Camira) – PG 3

Patina has a high content of natural fibers, combining wool and flax for a delicate feel. Drawing inspiration from Pattern in Nature revealed to us by its fine structure and carefully balanced colours. It is about designing with nature to achieve beauty with performance.

Composition:	69% Wool, 22% Flax, 8% Polyamide, 1% Viscose
Abrasion resistance:	> 100 000 Martindale
Flammability:	BS EN 1021: 1–2, BS 7176, BS 5852
Light fastness:	5 (EN ISO 105-B02)
Environmental facts:	EU Ecolabel, 100% free of heavy metals

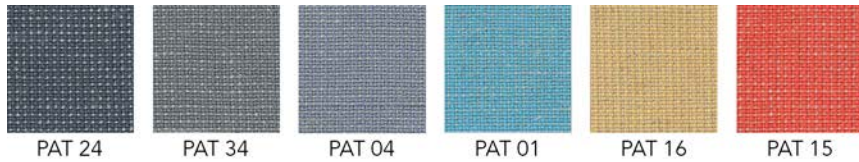

## Steelcut Trio 3 (Kvadrat) - Price group 4

Steelcut Trio 3 is a strong worsted wool and polyamide woven fabric, made with three different coloured yarns. The colours and the special weave create a three-dimensional surface where the colours seem to change depending on the angle of perspective. (Not available for HÅG Capisco Puls).

Composition:	90% worsted new wool, 10% polyamide
Abrasion resistance:	100 000 Martindale
Flammability:	AS/NZS 3837, Class 2, BS 5852, ig. s. 2-3, DIN 4102 B2, ÖNORM B1/Q1, EN1021-1/2, IMO MSC 307(88) Annex 1 part 8, NF D 60 013, NFPA 260, UNI 9175, 1IM, Calif. Bull. 117-2013
Light fastness:	5–7 (ISO 1–8)
Pilling:	4 (BS EN ISO 12945-2)
Environmental facts:	EU Ecolabel



## Comfort+ (Gabriel) - Price group 4

Comfort+ has a uniform stretchability and excellent non-pilling properties. A unique combination of fibres giving a durable soft surface.

Composition:	51% polyester, 37% recycled polyester, 12% polyurethane
Abrasion resistance:	150 000 Martindale
Flammability:	BS EN 1021: 1–2 (Cigarette & match), Calif. Bull. 117-2013, NFP 92-503:M3, ÖNORM B 3825-B2-3800-Q1 UK (Flován), UNI 9175 1IM, BS 5852 Part 1 0,1 (Cigarette & match)
Light fastness:	5–7 (EN ISO 105-B02)
Pilling:	5 (BS EN ISO 12945-2)
Environmental facts:	Oeko-Tex® Standard 100, 100% free of heavy metals

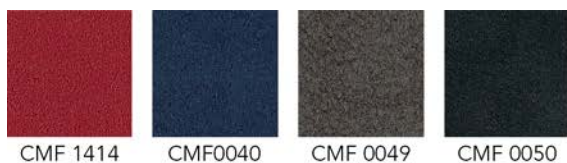

## Shimmer (Innvik Sellgren) - Price group 4

Satin-woven worsted wool combined with polyamide. The weave and fibre combination yields an irregular, glittering effect.

Composition:	80% wool, 20% recycled polyester
Abrasion resistance:	104 000 Martindale
Flammability:	BS EN 1021: 1-2 (Cigarette & match)
Light fastness:	5-7
Pilling:	4-5
Environmental facts:	Manufacturing process – fully compliant with ISO 14001



SHI 099

## Sirdal and Suldal (GU) - Price group 4

Sirdal and Suldal are part of the 100% Norwegian wool trio Sirdal, Suldal and Setesdal. These fabrics are uniquely short-travelled in every part of the process – 100% pure Norwegian wool manufactured in Norway.

Norwegian wool with its distinctive brilliance, resilience and durability is expressed through rich structures that evoke authenticity paired with chic and modern comfort.

Composition:	100% New Norwegian wool
Abrasion resistance:	> 57 000 Martindale
Flammability:	FTP code: Part 8 IMO MSC 307(88) Annex 1 part 8, EN ISO 12947-2:1999
Light fastness:	5-7
Pilling:	3-4 (BS EN ISO 12947-2)
Environmental facts:	Locally produced, 100% free of heavy metals



SRD 190



SUL 180



SUL 810



SRD 730

## Vadal Uni (GU) - Price group 4

High quality, fine felted new wool fabric with an inviting appearance and a warm touch.

Composition:	92% new wool, 8% polyamide
Abrasion resistance:	102 000 Martindale
Flammability:	BS EN 1021: 1-2 (Cigarette & match), IMO MSC 307(88) Annex 1 part 8
Light fastness:	5-7
Pilling:	3-4 (BS EN ISO 12947-2)
Environmental facts:	EU Ecolabel, 100% free of heavy metals, Manufacturing process - fully compliant with ISO 14001



VAU 191



## Paloma Soft (Wollsdorf) - Price group 6

High quality semi-aniline leather. All our standard colours from Paloma have a special finish adding a particular softness to the leather. Excellent friction and breathing properties. The surface may feature small scars and marks resulting from insect bites etc. These are proof of the natural origin of the product and are part of its character.

Flammability:	BS EN 1021: 1-2 (Cigarette & match), BS 5852 Crib 5, IMO MSC 307(88) Annex 1 part 8
Light fastness:	6 (EN ISO 105-B02)
Rubbing:	Wet 80/4 - Dry 1000/4 - Sweat 50/4 - ISO11640
Finish-adhesion:	≥ 2.5 N/CM - ISO 11644
Tear-strength:	≥ 20 N DIN EN ISO 3377-1
Environmental facts:	100% free of heavy metals, tanned without using chromium salts. BlueAngel, ECO <sub>2</sub> L-certificate



ATG 55130

ATG 55115

ATG 55206

ATG 55185

ATG 56100

---



Flokk is the market leader in the design, development and production of workplace furniture in Europe. We are the proud owner of product brands HÅG, RH, Giroflex, BMA, Offecct and RBM. About 700 employees work together to realize the vision of our company:

Inspire great work.

Our head office is in Oslo, Norway. We have production units in Røros (Norway), in Zwolle (the Netherlands), in Koblenz (Switzerland) and in Tibro and Nässjö (Sweden). In addition, we keep sales offices in Norway, Sweden, Denmark, Germany, Belgium, the Netherlands, UK, France, Switzerland, Singapore, USA, China and Australia. Flokk products are sold in more than 40 countries.

Zastoupení HAG pro ČR:

NORDESIGN s.r.o.

V Hůrkách 2139

15800 Praha 5

tel: 602207144

Headquarters

Flokk

Fridtjof Nansens vei 12 | P.O. Box 5055 Majorstuen

NO-0301 Oslo | Norway

Tel: +47 22 59 59 00 | Fax : +47 22 59 59 59

Customer service +47 72 40 72 40

Email: [info-gpo@flokk.com](mailto:info-gpo@flokk.com)

Web: [www.hag-global.com](http://www.hag-global.com) | [www.flokk.com](http://www.flokk.com)